

## Traversenteile F33 / Truss Parts F33

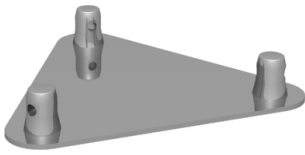

F33 Bodenplatte Male  
F33 Male base plate

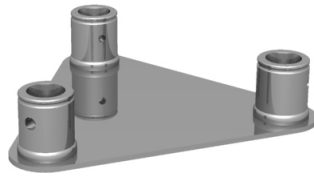

F33 Bodenplatte Female  
F33 Female base plate

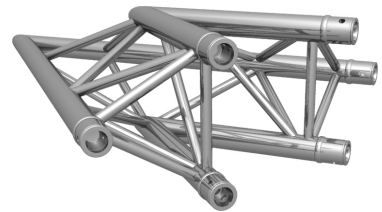

F33 2-Wege Ecke 45° außen  
F33 2-way corner 45° outside

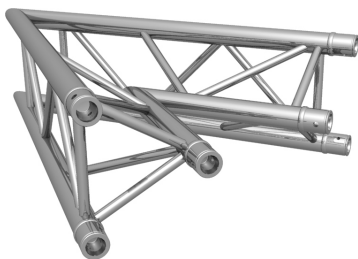

F33 2-Wege Ecke 45° innen  
F33 2-way corner 45° inside

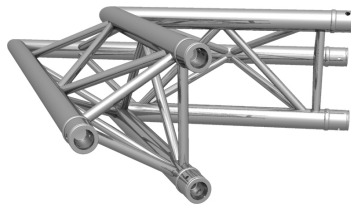

F33 2-Wege Ecke 60° außen  
F33 2-way corner 60° outside

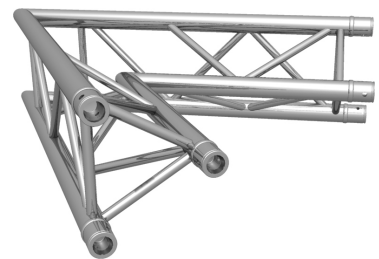

F33 2-Wege Ecke 60° innen  
F33 2-way corner 60° inside

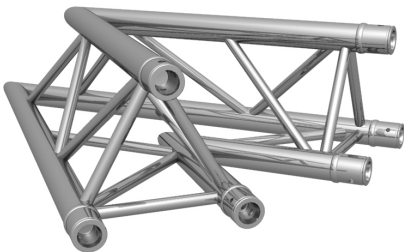

F33 2-Wege Ecke 45°  
F33 2-way corner 45°

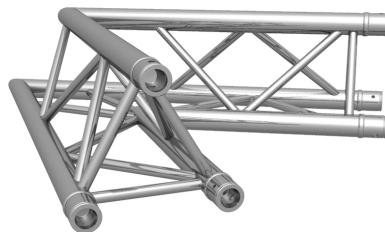

F33 2-Wege Ecke 60°  
F33 2-way corner 60°



F33 2-Wege Ecke 90°  
F33 2-way corner 90°



F33 2-Wege Ecke 120°  
F33 2-way corner 120°

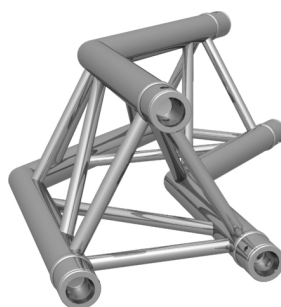

F33 2-Wege Ecke 135°  
F33 2-way corner 135°

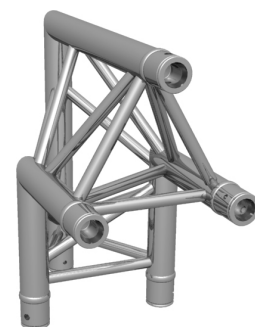

F33 2-Wege Ecke 90° außen  
F33 2-way corner 90° outside

## Traversenteile F33 / Truss Parts F33



F33 2-Wege Ecke 90° innen  
F33 2-way corner 90° inside



F33 2-Wege Ecke 120° außen  
F33 2-way corner 120° outside



F33 2-Wege Ecke 120° innen  
F33 2-way corner 120° inside



F33 2-Wege Ecke 135° außen  
F33 2-way corner 135° outside



F33 2-Wege Ecke 135° innen  
F33 2-way corner 135° inside

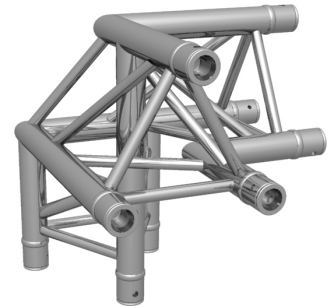

F33 3-Wege Ecke 90° oben/rechts  
F33 3-way corner 90° top/right

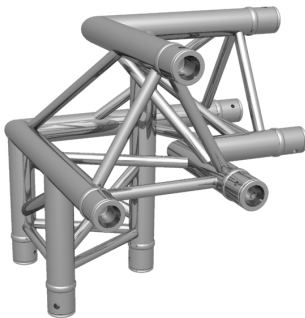

F33 3-Wege Ecke 90° oben/links  
F33 3-way corner 90° top/left

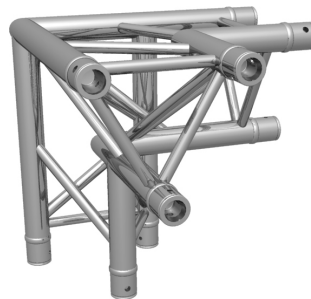

F33 3-Wege Ecke 90° unten/rechts  
F33 3-way corner 90° bottom/right



F33 3-Wege Ecke 90° unten/links  
F33 3-way corner 90° bottom/left

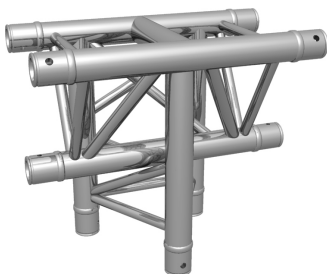

F33 3-Wege T-Stück vertikal  
F33 3-way T-piece vertical

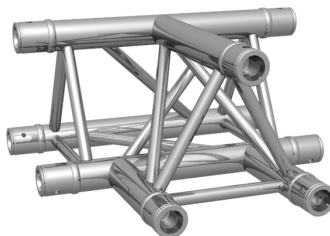

F33 3-Wege T-Stück horizontal  
F33 3-way T-piece horizontal

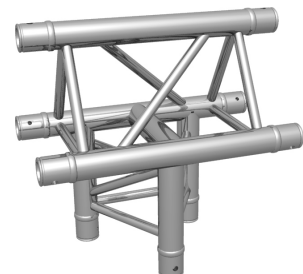

F33 3-Wege T-Stück vertikal  
F33 3-way T-piece vertical

## Traversenteile F33 / Truss Parts F33

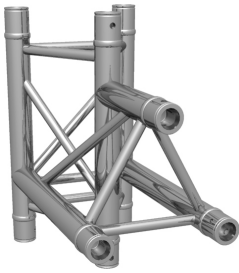

F33 3-Wege T-Stück vertikal  
F33 3-way T-piece vertical

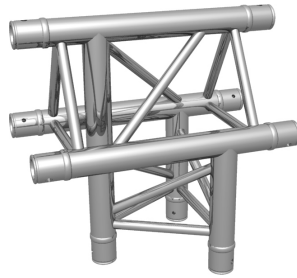

F33 3-Wege T-Stück horizontal  
F33 3-way T-piece horizontal

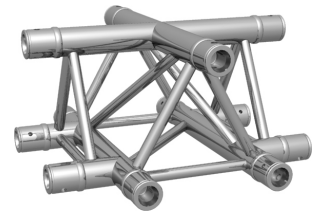

F33 4-Wege Kreuz  
F33 4-way cross

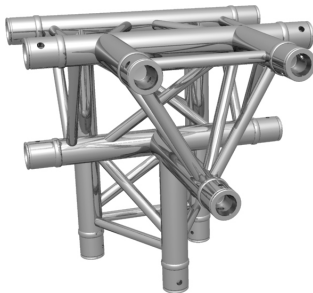

F33 4-Wege T-Stück unten  
F33 4-way T-piece bottom

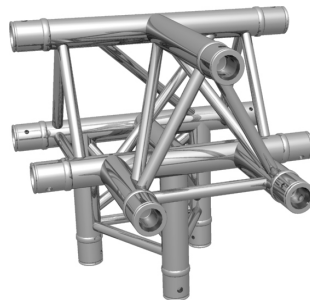

F33 4-Wege T-Stück oben  
F33 4-way T-piece top

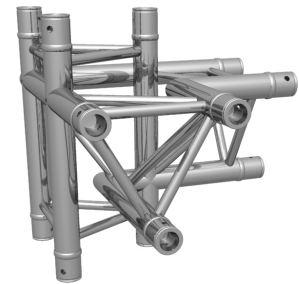

F33 4-Wege Ecke unten/rechts  
F33 4-way corner bottom/right

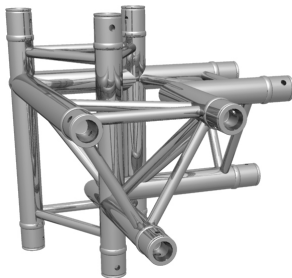

F33 4-Wege Ecke unten/links  
F33 4-way corner bottom/left

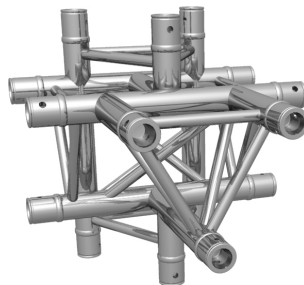

F33 5-Wege T-Stück  
F33 5-way T-piece

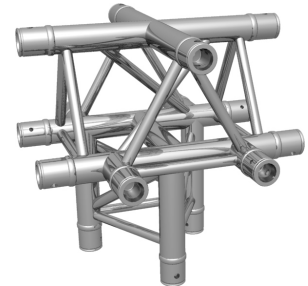

F33 5-Wege Ecke  
F33 5-way corner

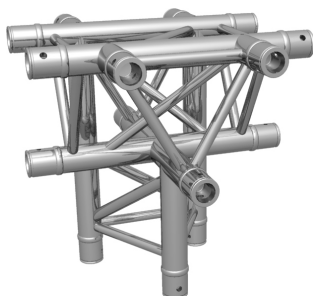

F33 5-Wege Ecke  
F33 5-way corner

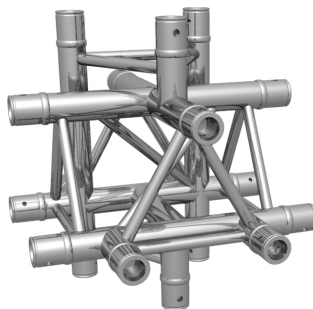

F33 6-Wege Ecke  
F33 6-way corner



F33 25 cm  
F33 25 cm

## Traversenteile F33 / Truss Parts F33



F33 50 cm  
F33 50 cm

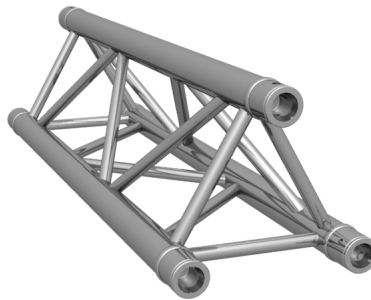

F33 100 cm  
F33 100 cm

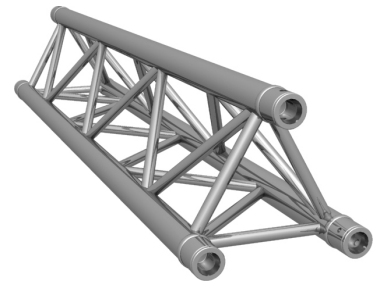

F33 150 cm  
F33 150 cm

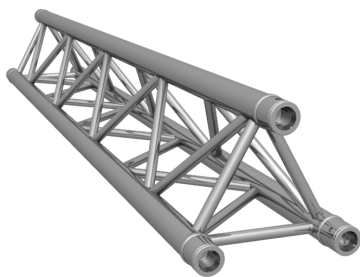

F33 200 cm  
F33 200 cm

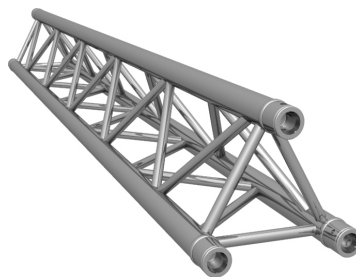

F33 250 cm  
F33 250 cm

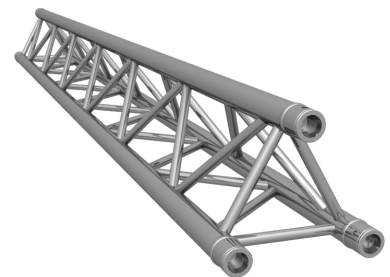

F33 300 cm  
F33 300 cm

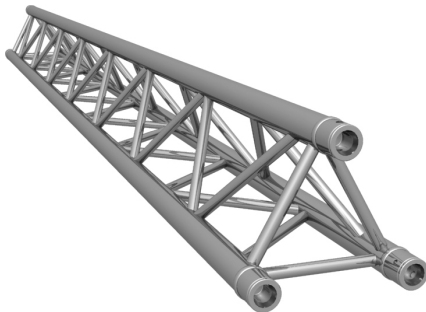

F33 350 cm  
F33 350 cm

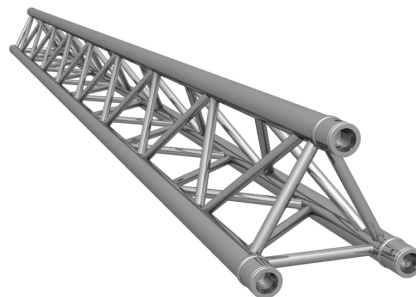

F33 400 cm  
F33 400 cm

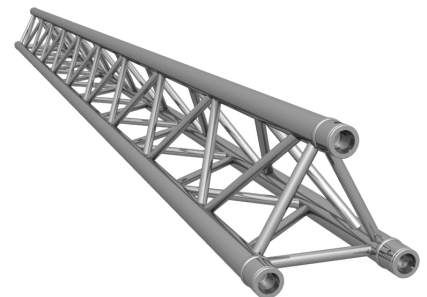

F33 450 cm  
F33 450 cm

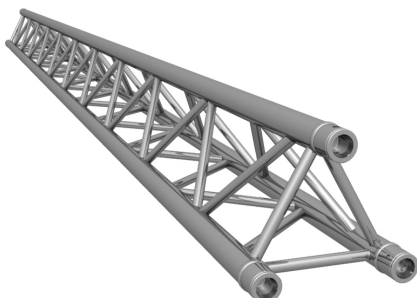

F33 500 cm  
F33 500 cm

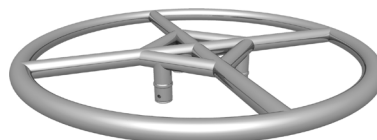

F33 Kreisauflauf  
F33 circle top



F33 Kreis 2 m  
F33 circle 2 m

## Traversenteile F33 / Truss Parts F33

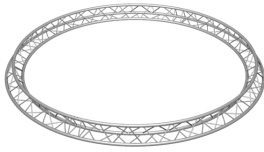

F33 Kreis 3 m  
F33 circle 3 m

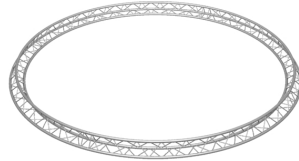

F33 Kreis 4 m  
F33 circle 4 m

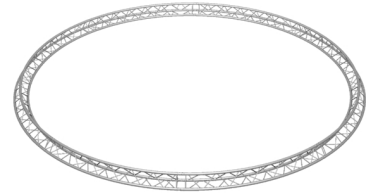

F33 Kreis 5 m  
F33 circle 5 m

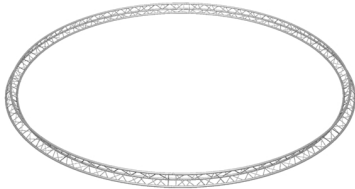

F33 Kreis 6 m  
F33 circle 6 m

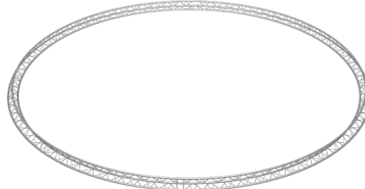

F33 Kreis 7 m  
F33 circle 7 m

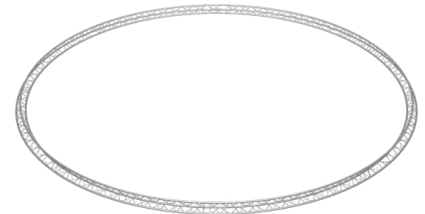

F33 Kreis 8 m  
F33 circle 8 m

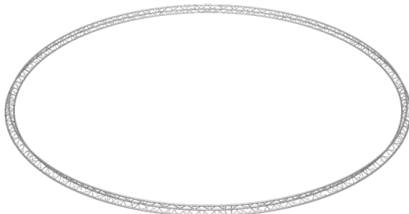

F33 Kreis 9 m  
F33 circle 9 m

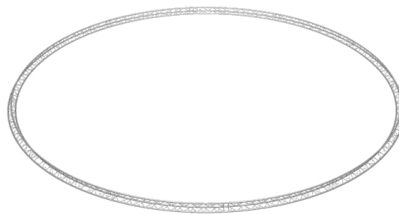

F33 Kreis 10 m  
F33 circle 10 m

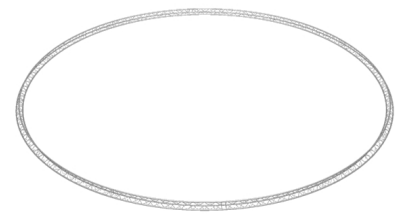

F33 Kreis 11 m  
F33 circle 11 m

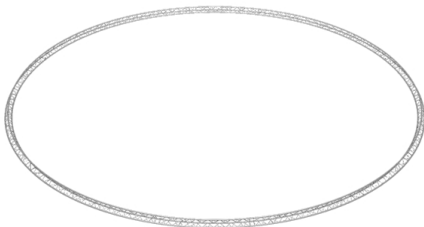

F33 Kreis 12 m  
F33 circle 12 m