

Traversenteile F32 / Truss Parts F32

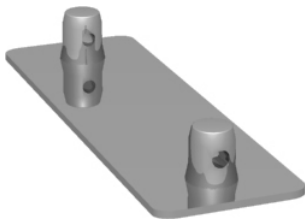

F32 Bodenplatte Male
F32 Male base plate

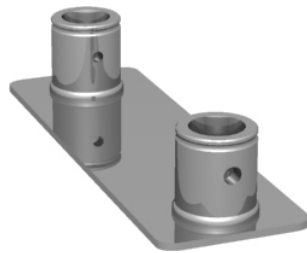

F32 Bodenplatte Female
F32 Female base plate



F32 Radius horizontal
F32 Radius horizontal

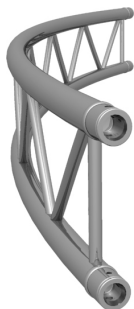

F32 Radius vertikal
F32 Radius vertical

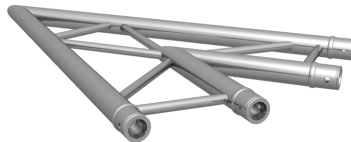

F32 2-Wege Ecke 45° horizontal
F32 2-way corner 45° horizontal

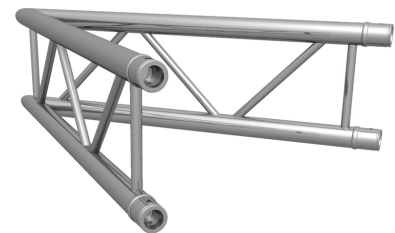

F32 2-Wege 45° vertikal
F32 2-way 45° vertical



F32 2-Wege Ecke 60° horizontal
F32 2-way corner 60° horizontal

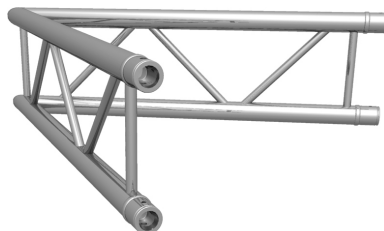

F32 2-Wege Ecke 60° vertikal
F32 2-way corner 60° vertical

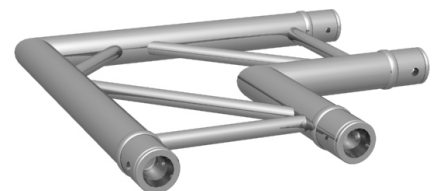

F32 2-Wege 90° horizontal
F32 2-way 90° horizontal

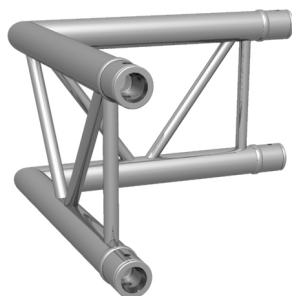

F32 2-Wege 90° vertikal
F32 2-way 90° vertical

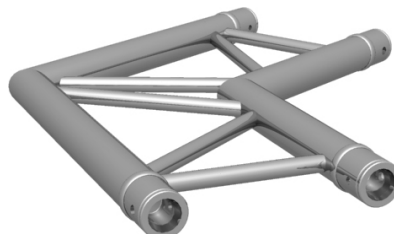

F32 2-Wege 120° horizontal
F32 2-way 120° horizontal

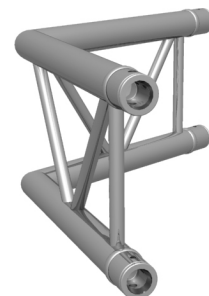

F32 2-Wege 120° vertikal
F32 2-way 120° vertical

Traversenteile F32 / Truss Parts F32

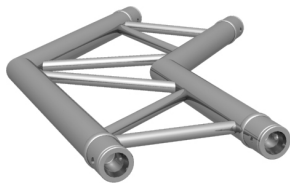

F32 2-Wege 135° horizontal
F32 2-way 135° horizontal

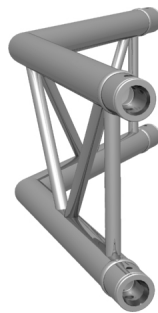

F32 2-Wege 135° vertikal
F32 2-way 135° vertical



F32 3-Wege 90° horizontal
F32 3-way 90° horizontal

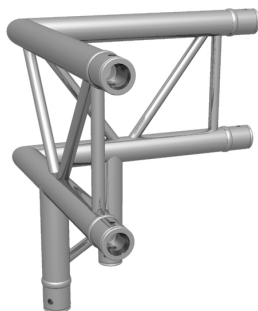

F32 3-Wege 90° vertikal
F32 3-way 90° vertical

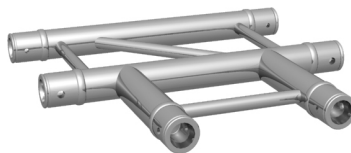

F32 3-Wege T-Stück horizontal
F32 3-way T-piece horizontal

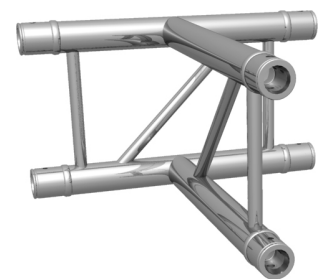

F32 3-Wege T-Stück vertikal
F32 3-way T-piece vertical

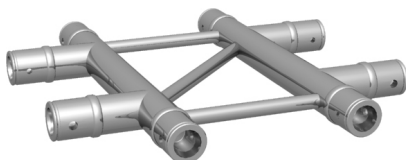

F32 4-Wege Kreuz horizontal
F32 4-way cross horizontal

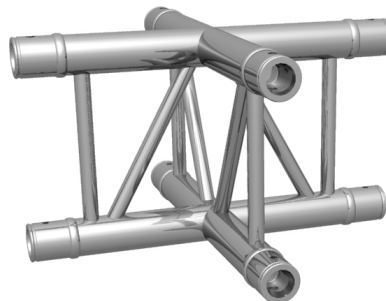

F32 4-Wege Kreuz vertikal
F32 4-way cross vertical

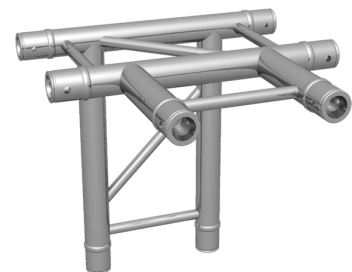

F32 4-Wege T-Stück horizontal
F32 4-way T-piece horizontal

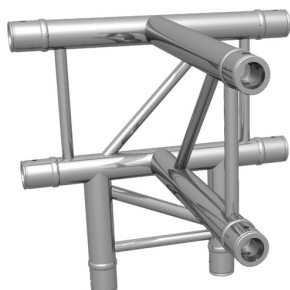

F32 4-Wege T-Stück horizontal
F32 4-way T-piece horizontal

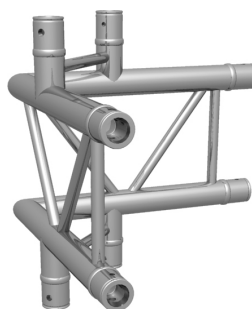

F32 4-Wege Ecke vertikal
F32 4-way corner vertical



F32 25 cm
F32 25 cm

Traversenteile F32 / Truss Parts F32



F32 50 cm
F32 50 cm

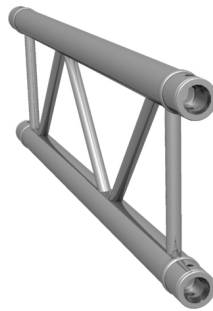

F32 100 cm
F32 100 cm

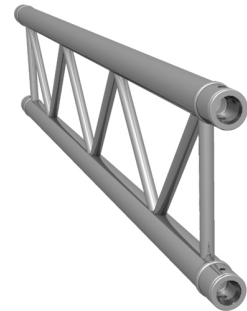

F32 150 cm
F32 150 cm

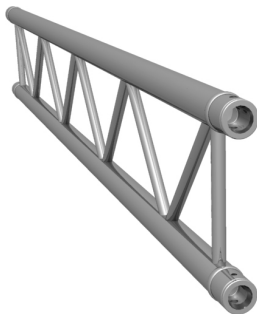

F32 200 cm
F32 200 cm

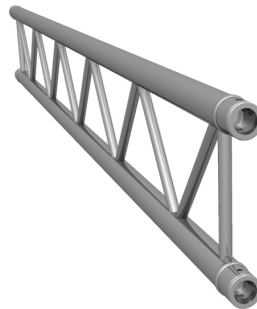

F32 250 cm
F32 250 cm

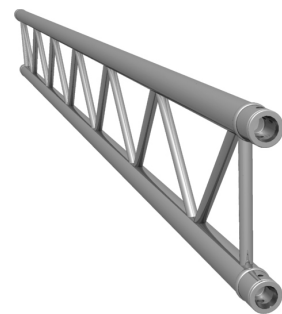

F32 300 cm
F32 300 cm

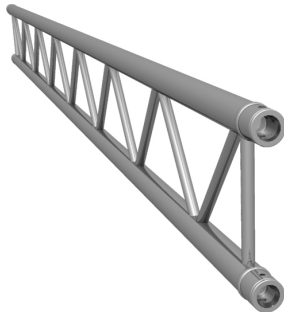

F32 350 cm
F32 350 cm

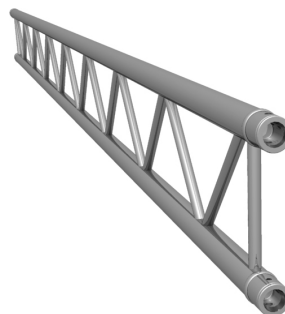

F32 400 cm
F32 400 cm

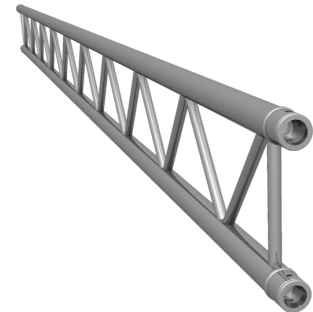

F32 450 cm
F32 450 cm

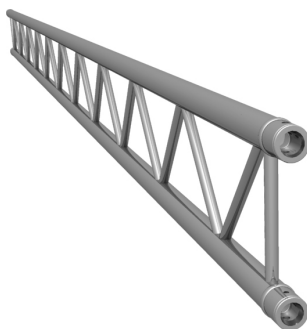

F32 500 cm
F32 500 cm