

Traversenteile F23 / Truss Parts F23

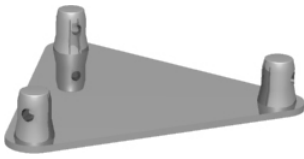

F23 Bodenplatte Male
F23 Male base plate

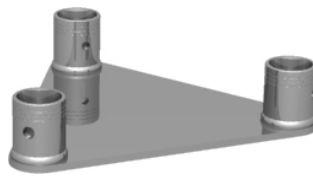

F23 Bodenplatte Female
F23 Female base plate



F23 2-Wege Ecke 45° außen
F23 2-way corner 45° outside

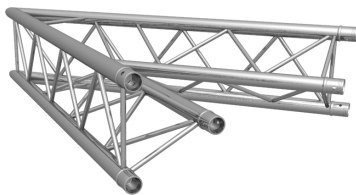

F23 2-Wege Ecke 45° innen
F23 2-way corner 45° inside

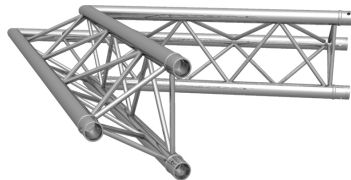

F23 2-Wege Ecke 60° außen
F23 2-way corner 60° outside

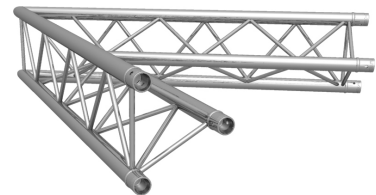

F23 2-Wege Ecke 60° innen
F23 2-way corner 60° inside

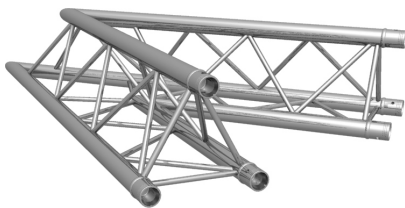

F23 2-Wege Ecke 45°
F23 2-way corner 45°



F23 2-Wege Ecke 60°
F23 2-way corner 60°

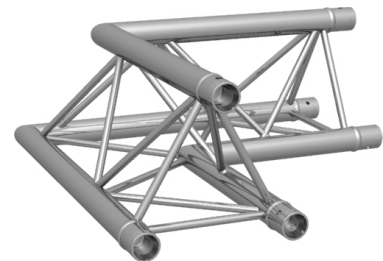

F23 2-Wege Ecke 90°
F23 2-way corner 90°

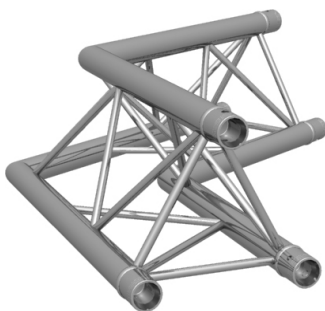

F23 2-Wege Ecke 120°
F23 2-way corner 120°

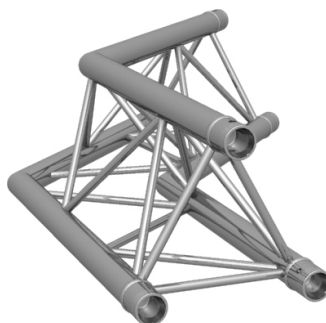

F23 2-Wege Ecke 135°
F23 2-way corner 135°

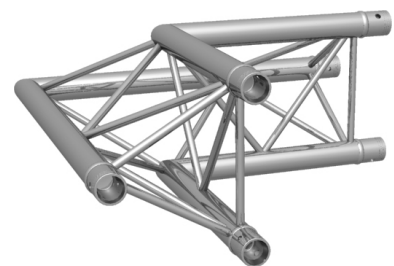

F23 2-Wege Ecke 90° außen
F23 2-way corner 90° outside

Traversenteile F23 / Truss Parts F23

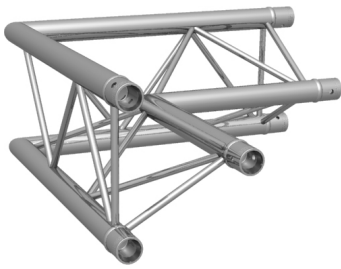

F23 2-Wege Ecke 90° innen
F23 2-way corner 90° inside

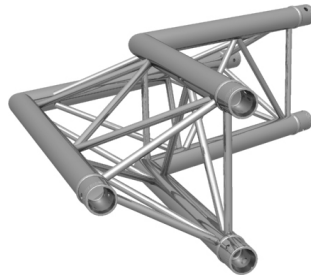

F23 2-Wege Ecke 120° außen
F23 2-way corner 120° outside



F23 2-Wege Ecke 120° innen
F23 2-way corner 120° inside

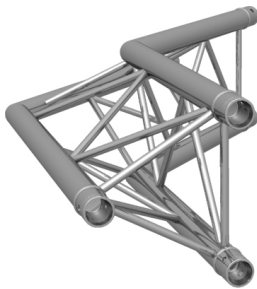

F23 2-Wege Ecke 135° außen
F23 2-way corner 135° outside

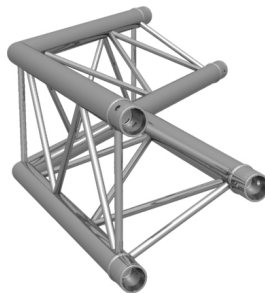

F23 2-Wege Ecke 135° innen
F23 2-way corner 135° inside

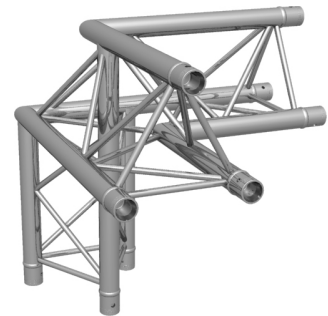

F23 3-Wege Ecke 90° oben/rechts
F23 3-way corner 90° top/right

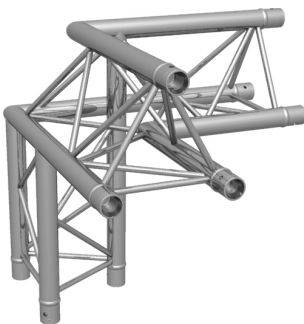

F23 3-Wege Ecke 90° oben/links
F23 3-way corner 90° top/left

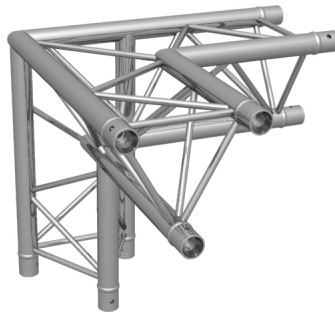

F23 3-Wege Ecke 90° unten/rechts
F23 3-way corner 90° bottom/right

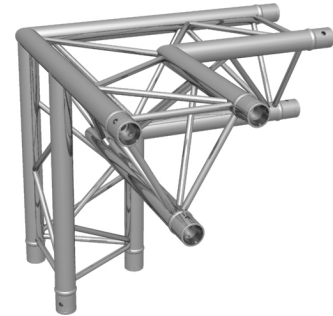

F23 3-Wege Ecke 90° unten/links
F23 3-way corner 90° bottom/left

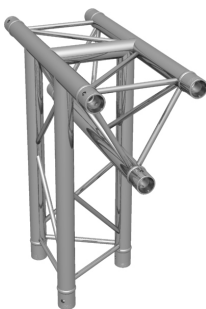

F23 3-Wege T-Stück vertikal
F23 3-way T-piece vertical

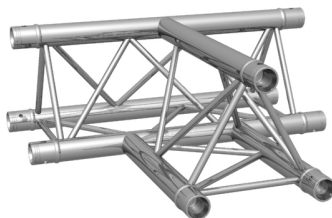

F23 3-Wege T-Stück horizontal
F23 3-way T-piece horizontal

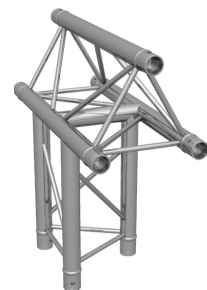

F23 3-Wege T-Stück vertikal
F23 3-way T-piece vertical

Traversenteile F23 / Truss Parts F23

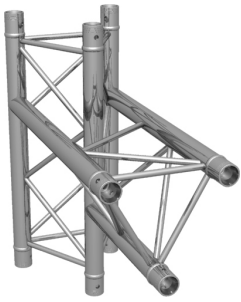

F23 3-Wege T-Stück vertikal
F23 3-way T-piece vertical

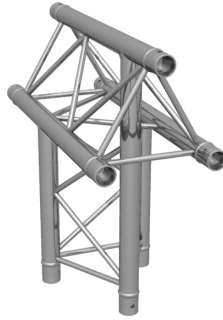

F23 3-Wege T-Stück horizontal
F23 3-way T-piece horizontal

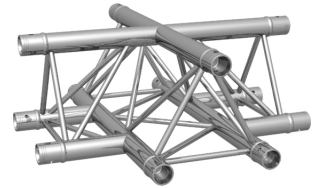

F23 4-Wege Kreuz
F23 4-way cross

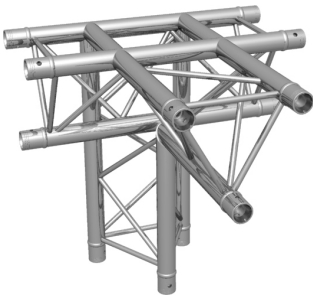

F23 4-Wege T-Stück unten
F23 4-way T-piece bottom

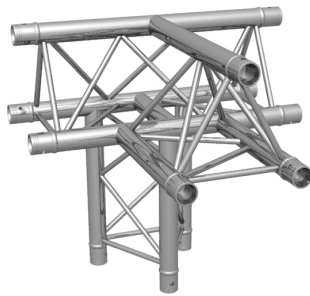

F23 4-Wege T-Stück oben
F23 4-way T-piece top

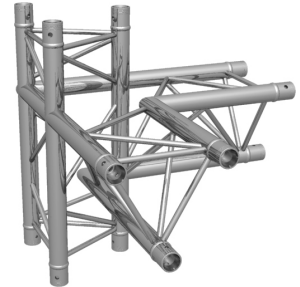

F23 4-Wege Ecke unten/rechts
F23 4-way corner bottom/right

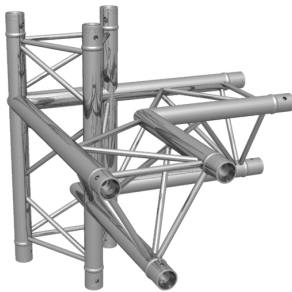

F23 4-Wege Ecke oben/links
F23 4-way corner top/left

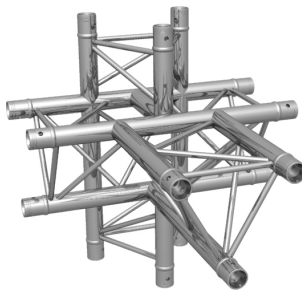

F23 5-Wege T-Stück
F23 5-way T-piece



F23 25 cm
F23 25 cm

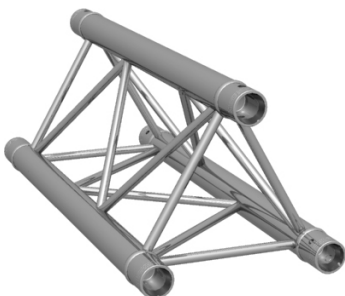

F23 50 cm
F23 50 cm

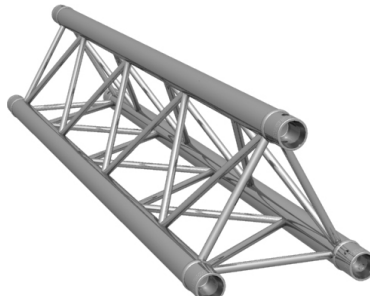

F23 100 cm
F23 100 cm

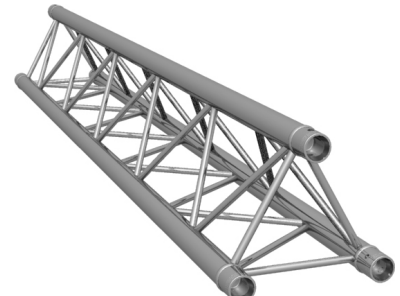

F23 150 cm
F23 150 cm

Traversenteile F23 / Truss Parts F23

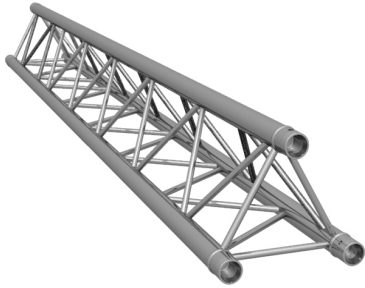

F23 200 cm
F23 200 cm

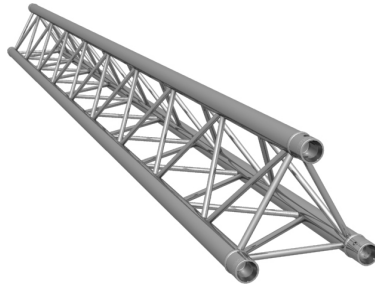

F23 250 cm
F23 250 cm

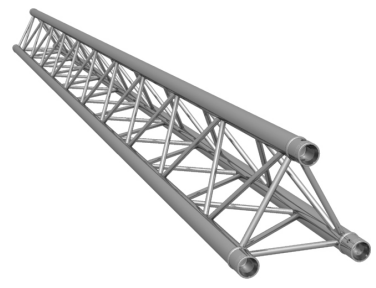

F23 300 cm
F23 300 cm

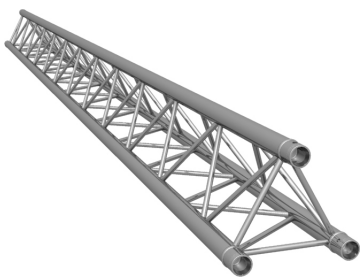

F23 350 cm
F23 350 cm

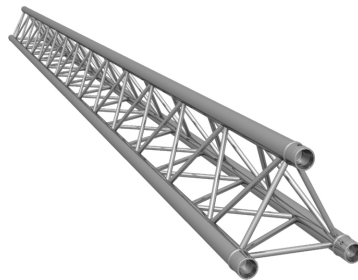

F23 400 cm
F23 400 cm

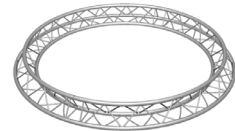

F23 Kreis 2 m
F23 circle 2 m

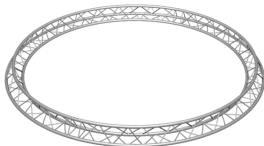

F23 Kreis 3 m
F23 circle 3 m

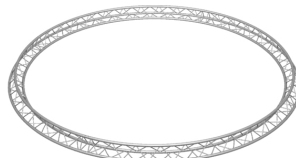

F23 Kreis 4 m
F23 circle 4 m

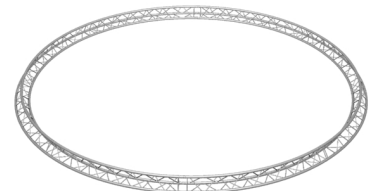

F23 Kreis 5 m
F23 circle 5 m

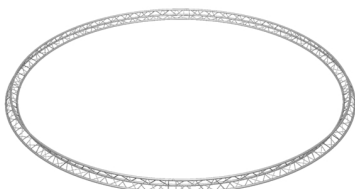

F23 Kreis 6 m
F23 circle 6 m



F23 Kreis 7 m
F23 circle 7 m



F23 Kreis 8 m
F23 circle 8 m

Traversenteile F23 / Truss Parts F23

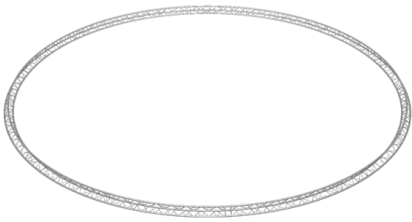

F23 Kreis 9 m
F23 circle 9 m

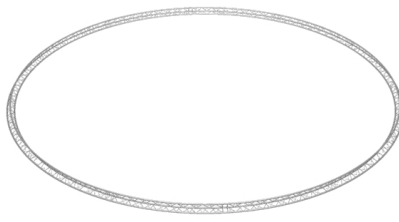

F23 Kreis 10 m
F23 circle 10 m

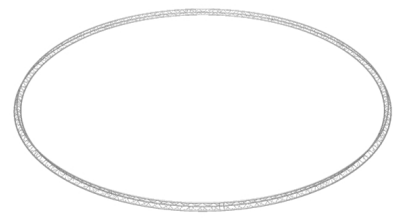

F23 Kreis 11 m
F23 circle 11 m

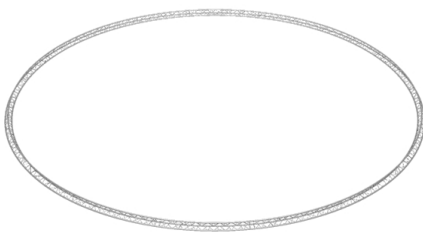

F23 Kreis 12 m
F23 circle 12 m